



IMPORTANT FOR FUTURE REFERENCE

Please complete this information and retain this manual for the life of the equipment:

Model #: _____

Serial #: _____

Date Purchased: _____

INSTALLATION & OPERATION MANUAL

Gas Tilting Skillets GTS-30 GTS-40

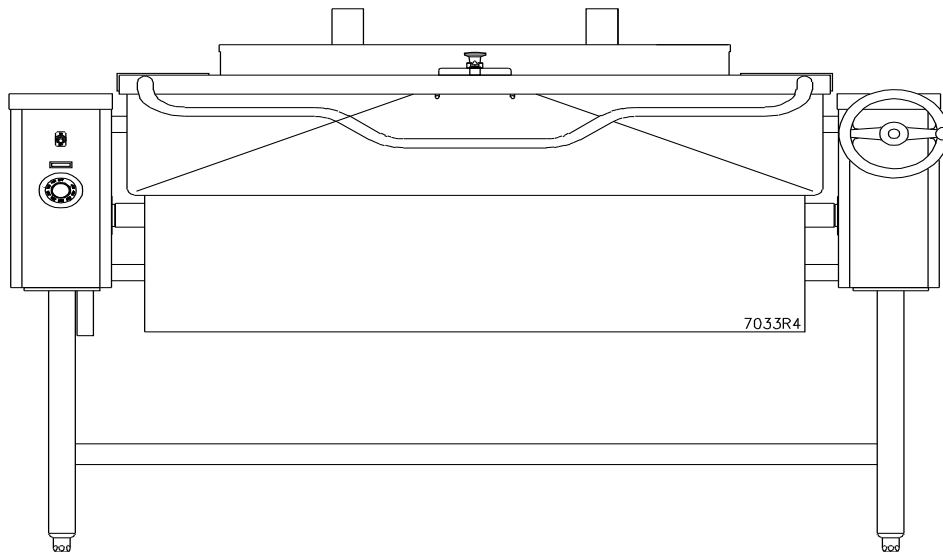

 **WARNING**

Improper installation, adjustment, alteration, service or maintenance can cause property damage, injury or death. Read the installation, operating and maintenance instructions thoroughly before installing or servicing this equipment.

CROWN FOOD SERVICE EQUIPMENT

 A Middleby Company

70 Oakdale Road, Downsview (Toronto) Ontario, Canada, M3N 1V9

Telephone: 919-762-1000 www.crownsteamgroup.com

Printed in Canada



IMPORTANT NOTES FOR INSTALLATION AND OPERATION

It is recommended that this manual be read thoroughly and that all instructions be followed carefully. This manual should be retained for future reference.



This is the safety alert symbol. It is used to alert you to potential personal injury hazards. Obey all safety messages that follow this symbol to avoid possible injury or death.



FOR YOUR SAFETY: Do not store or use gasoline or other flammable vapors or liquids in the vicinity of this or any other appliance.

PURCHASER: Instructions to be followed in the event that the operator of this appliance smells gas must be posted in a prominent location. This information shall be obtained by consulting the local gas supplier.



WARNING: In the event you smell gas, shut down equipment at the main shut off valve and contact the local gas company or gas supplier for service.

Do not attempt to operate this unit in the event of a power failure.

Keep the appliance area free and clear from combustibles.

Do not obstruct the flow of combustion and ventilation air.

Adequate clearances must be maintained for servicing and proper operation.



WARNING: Improper installation, operation, adjustment, alteration, service or maintenance can cause property damage, injury or death. Read the installation, operating and maintenance instructions thoroughly before installing, operating or servicing this equipment.

NOTICE: Contact the factory, the factory representative or local service company to perform maintenance and repairs.

TABLE OF CONTENTS

DESCRIPTION	PAGE
Important Notes for Installation and Operation	2
Service Connections	4
1.0 Installation Instructions	5
2.0 Operating Instructions	9
3.0 Cleaning	11
4.0 Maintenance	11
5.0 Troubleshooting	12

INSTALLATION AND OPERATION MANUAL, GAS SKILLETS, MODELS GTS-30, GTS-40

SERVICE CONNECTIONS

- Ⓐ - Supply gas through 3/4" pipe . A gas shut-off valve is installed in supply piping.
- Ⓔ - Electrical Connection, unless otherwise specified 120 Volts, 60 Hz, 1 PH. furnished with 3 prong plug and cord (8'). Less than 2 amperes.
- Ⓒ - COLD WATER: Compression fitting for 5/8 O.D. copper tubing or 1/2 NPSM male.
- Ⓓ - HOT WATER:: Compression fitting for 5/8 O.D. copper tubing or 1/2 NPSM male.

DIMENSIONS

MODEL	CAPACITY	UNITS	A	B	C	D	E	F	G	H	J	
											ø2	ø3
GTS-30	30 gallons	inches	49.63	40.75	33.5	23.50	43.13	37.5	43	71.88	42	46.5
	114 litres	mm	1257	1035	851	597	1095	953	1092	1826	1067	1181
GTS-40	40 gallons	inches	58.63	40.25	43.5	23.0	52.13	37.5	42.13	71.88	1067	1181
	152 litres	mm	1489	1022	1105	584	1324	953	1070	1826		

MODEL	SHIPPING WT.	GAS SUPPLY			MIN. CLEARANCE *		
		BTU/HR.	kW/HR.	SUPPLY PIPE PRESSURE (W.C.)			
GTS-30	684 lbs. [310 kg]	80,000	23.4	Natural	Propane	SIDES	0
				7"-14" (178-356mm)	11"-14" (279-356mm)		
GTS-40	725 lbs. [328 kg]	100,000	29.3			BACK	6 [152]

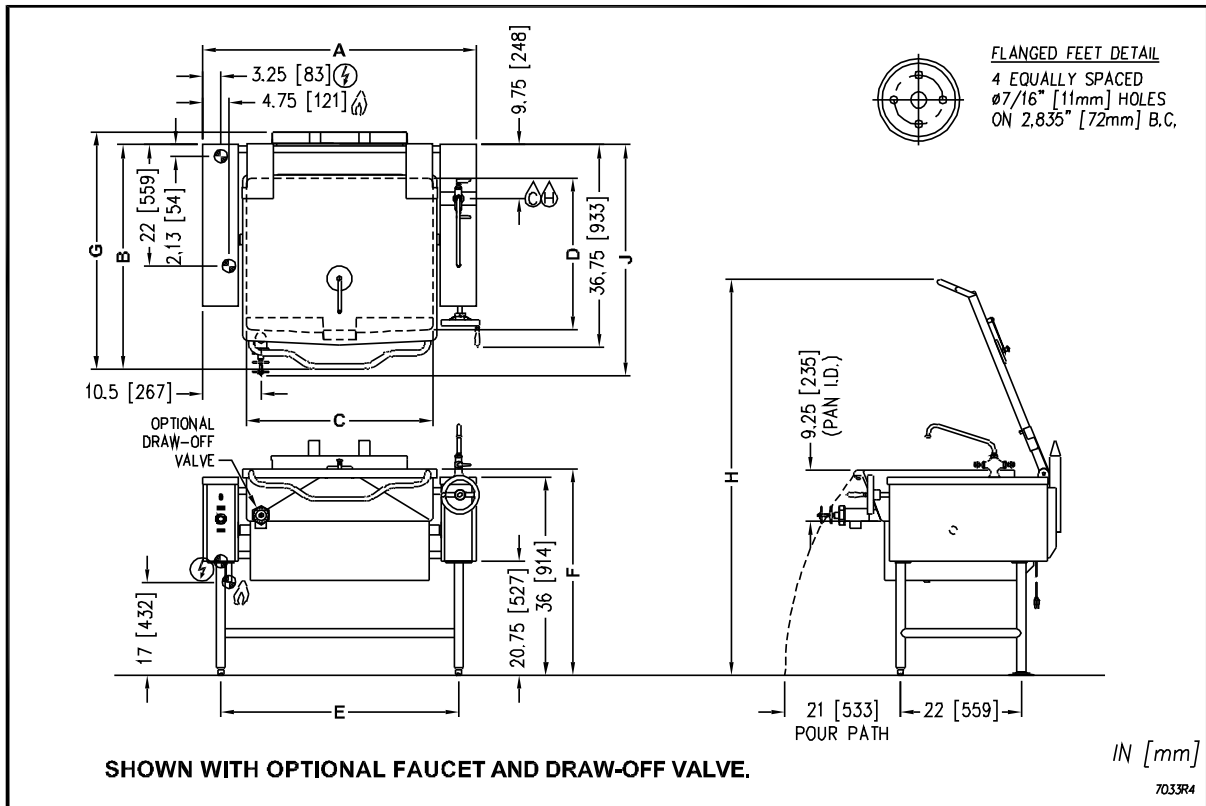

As continued product improvement is a policy of Crown, specifications are subject to change without notice.

1.0 INSTALLATION INSTRUCTIONS

INSTALLATION CODES AND STANDARDS

Installation must conform with local codes, or in the absence of local codes, with the *National Fuel Gas Code, ANSI Z223.1/NFPA 54*, or the *Natural Gas and Propane Installation Code, CSA B149.1*, as applicable.

1. The appliance and its individual shut off valve must be disconnected from the gas supply piping system during any pressure testing of that system at pressures in excess of ½ psi (3.5 kPa).
2. The appliance must be isolated from the gas supply piping system by closing its individual manual shut off valve during any pressure testing of the gas supply piping system at test pressures equal to or less than ½ psi (3.5 kPa).

Electrical grounding must be provided in accordance with local codes, or in the absence of local codes, with the National Electrical Code, ANSI/NFPA 70, or the Canadian Electrical Code, CSA C22.2, as applicable.

FLUE CONNECTIONS

Do not obstruct the flow of flue gases from the flue duct located on the rear of the gas fired tilting skillet. It is recommended that the flue gases be ventilated to the outside of the building through a ventilation system installed by qualified personnel.

Information on the construction and installation of ventilating hoods may be obtained from the standard for "Vapour Removal from Cooking Equipment", NFPA No. 96 (latest edition), available from the National Fire Protection Association, Batterymarch Park, Quincy, MA, U.S.A. 02269.

UNPACKING

Immediately after unpacking, check for possible shipping damage. If the gas fired tilting skillet is found to be damaged, save the packaging material and contact the carrier within 15 days of delivery.

Before installing, verify that the type of gas supply (natural or propane) and electrical service agree with the specifications on the rating plate located on the left side console as you face the front of the appliance. If the supply and equipment requirements do not agree, contact your dealer immediately.

1.0 INSTALLATION INSTRUCTIONS (Continued)

LOCATION

The equipment must be kept free and clear of combustible substances. The appliance, when installed, must have minimum clearance from combustible and non-combustible construction of 0" from sides and 6" (152 mm) from the rear. The appliance is intended for use on non-combustible floors.

The installation location must allow adequate clearances for servicing and proper operation. A minimum front clearance of 36" (914 mm) is required.

The appliance must be installed so that the flow of combustion and ventilation air will not be obstructed. Adequate clearance for air openings into the combustion chamber must be provided. Make sure there is an adequate supply of air in the room suitable for the amount of combustion gas feeding the burners.

Do not permit fans to blow directly at the appliance, and wherever possible, avoid open windows next to the appliance. Avoid wall-type fans which create air cross currents within the room.

LEVELLING AND ANCHORING (For appliances not equipped with casters)

1. Set the appliance in place and level left to right and front-to-back using spirit level.
2. Mark hole locations on floor through anchoring holes provided in flanged adjustable feet.
3. Remove appliance and drill holes in locations marked on floor and insert proper anchoring devices (not supplied).
4. Set unit back in position and re-level left to right and front to back.
5. Bolt and anchor appliance securely to the floor.
6. Seal bolts and flanged feet with Silastic or equivalent compound.

1.0 INSTALLATION INSTRUCTIONS (Continued)

GAS CONNECTIONS

All gas supply connections and any pipe joint compound used must be resistant to the action of propane gases.

The gas inlet is located under the left hand control console.

Connect gas supply to the appliance. The gas supply line must be at least the equivalent of 3/4" iron pipe with an incoming pressure of 7" - 14" W.C. (Water Column) for natural gas or 11" - 14" W.C. (Water Column) for propane gas. Make sure the pipes are clean and free of obstructions, dirt and piping compound.

Codes require that a gas shutoff valve be installed in the gas line ahead of the tilting braising pan.

Natural gas and propane gas skillets are equipped with fixed orifices and no adjustment is necessary. Gas burner manifold is set at 3.5" W.C. (Water Column) for natural gas, and 10" W.C. (Water Column) for propane gas.

After piping has been checked for leaks, all piping receiving gas should be fully purged to remove air.

ELECTRICAL CONNECTION

	<p>WARNING: ELECTRICAL GROUNDING INSTRUCTIONS This appliance is equipped with a three-prong (grounding) plug for your protection against shock hazard and should be plugged directly into a properly grounded three-prong receptacle. Do not cut or remove the grounding prong from this plug. (120V units only).</p>
-------------------------------------------------------------------------------------	----------------------------------------------------------------------------------------------------------------------------------------------------------------------------------------------------------------------------------------------------------------------------------------------------------------------------------

The electrical wiring diagram is located inside the left-hand skillet console.

The wiring compartment is located in the left hand control console. For units operated on electrical supply other than 120 volts, remove the left hand console cover and make electrical connections per the wiring diagram located inside. The skillet must be grounded in accordance with requirements of the National Electrical Code or applicable local code.

Replace console cover.

1.0 **INSTALLATION INSTRUCTIONS** (Continued)

	<p>WARNING: For an appliance equipped with casters, the installation shall be made with a connector that complies with the Standard for Connectors for Moveable Gas Appliances, ANSI Z21.69-CSA 6.16 and a quick-disconnect device that complies with the Standard for Quick-Disconnect Devices for Use with Gas Fuel, ANSI Z21.41-CSA 6.9; adequate means must be provided to limit the movement of the appliance without depending on the connector and the quick-disconnect device or its associated piping to limit the appliance movement; the location where the restraining means may be attached to the appliance is the bottom rear of the left hand control console.</p> <p>If the unit is also equipped with an optional water fill valve it too must be installed with a flexible water supply tube, a quick disconnect and strain relief.</p>
-----------------------------------------------------------------------------------	-------------------------------------------------------------------------------------------------------------------------------------------------------------------------------------------------------------------------------------------------------------------------------------------------------------------------------------------------------------------------------------------------------------------------------------------------------------------------------------------------------------------------------------------------------------------------------------------------------------------------------------------------------------------------------------------------------------------------------------------------------------------------------------------------------------------------------------------------------------------

2.0 OPERATING INSTRUCTIONS

	CAUTION: The appliance and its parts are hot. Use care when operating, cleaning and servicing the appliance.
-----------------------------------------------------------------------------------	---------------------------------------------------------------------------------------------------------------------

BEFORE FIRST USE

Using a non-corrosive, grease-dissolving commercial cleaner, clean the protective metal oils from all surface parts and the interior of the tilting braising pan. Follow the cleaner manufacturer's directions. Rinse thoroughly and drain the pan. Wipe dry with a soft clean cloth.

LIGHTING

	CAUTION: If you smell gas during the lighting procedure, immediately shut off the gas supply until the leak has been corrected.
-----------------------------------------------------------------------------------	----------------------------------------------------------------------------------------------------------------------------------------

	WARNING: In the event of main burner ignition failure, a 5 minute purge period must be observed prior to re-establishing ignition source.
-------------------------------------------------------------------------------------	--------------------------------------------------------------------------------------------------------------------------------------------------

1. Open the manual gas shut-off valve located under the left hand console, when facing the front of the unit.
2. Ensure that the skillet pan is in the down or horizontal position.
3. Turn the "POWER" switch "ON".
4. Set the thermostat dial to the desired setting. The red "TEMPERATURE" pilot will be on until the desired setting has been reached.
5. The green "IGNITION" pilot should remain on with the "TEMPERATURE" pilot, indicating normal ignition and operation. If the "IGNITION" pilot goes off while the "TEMPERATURE" pilot remains on, this indicates that the system has failed to ignite the burners. A five minute period of complete shut off is required before restarting.
6. When the skillet has reached the setting, both pilots will go off, indicating the unit has reached the set temperature and that the burners are off. The unit will cycle on and off to maintain the set temperature.

LIGHTING (Continued)

7. Turn the “POWER” switch to “OFF” when the skillet is not in use and close the manual gas shut-off valve.

DAILY SHUTDOWN PROCEDURE

1. Turn thermostat dial to off; turn power switch off.
2. Close manual gas shut-off valve.

TO TILT SKILLET

1. Lift lid.
2. Turn handwheel clockwise to desired position.

NOTE: When the pan is tilted a safety switch will automatically turn off gas supply. The skillet will not operate once the pan has been tilted.

3. To return pan to horizontal position, turn handwheel counterclockwise.
4. **DO NOT ATTEMPT TO TILT PAN WITH LID DOWN.**

3.0 CLEANING

	WARNING: Disconnect the power supply to the appliance before cleaning or servicing.
-----------------------------------------------------------------------------------	--------------------------------------------------------------------------------------------

	WARNING: The appliance and its parts are hot. Use care when operating, cleaning and servicing the skillet.
-----------------------------------------------------------------------------------	-------------------------------------------------------------------------------------------------------------------

The gas fired tilting skillet should be cleaned after each use.

1. Keep exposed cleanable areas of unit clean at all times.
2. Thoroughly wash pan and lid. If necessary soak pan to remove product that is stuck to pan surface. Use mild detergent and water.
3. Clean around burner air mixer and orifice if lint has accumulated.
4. Visually assure carry-over ports are unobstructed.
5. Rinse entire unit and dry. Do not get water in electrical box or any electrical component.

4.0 MAINTENANCE

At least twice a year, have an authorized service person clean and adjust the unit for maximum performance.

	WARNING: At least twice a year, have an authorized service person inspect and lubricate the tilt mechanism, replacing any worn or damaged parts.
-------------------------------------------------------------------------------------	---------------------------------------------------------------------------------------------------------------------------------------------------------

All units are adjusted at the factory. In case of problems in operation at initial installation, check type of gas and manifold pressure and compare it with information on rating plate.

5.0 TROUBLESHOOTING

PROBLEM

Burner does not come on:

LOOK FOR:

Gas supply to unit is "OFF"

Manual shut off valve is "OFF".

Thermostat is not turned "ON"

Pan not in lowest position.

Ignition control not functioning.

Unit electrical supply is not plugged in or turned on.

Burners produce carbon deposits:

Wrong size orifices.

Burner air not adjusted properly.

Wrong gas supply.

Incorrect pressure at supply.

Pan difficult to tilt:

Unit not level.

Trunnion housing requires grease.

Thrust bearing too tight.

Segment gear worn.

Worm gear worn.